

VA 525 - Compact Inline flow meter

No inlet sections necessary – integrated flow straightener

The newly developed VA 525 combines modern digital interfaces for connection to an energy monitoring system with a small, compact design. The VA 525 is always used when many machines (compressed air consumers) are to be integrated into an energy monitoring network.



Display values can be rotated 180° in the display, e. g. when installing overhead

Display shows 2 values at the same time:

- Current consumption in m³/h, l/min,...
- Total consumption (meter reading) in m³, l, kg
- Temperature measurement
- **Optional:** pressure measurement

The advantages at a glance:

- Compact, small design - for use in machines, behind maintenance unit at the end user
- Optionally with classic analogue signals (4...20 mA and pulse) or digital interfaces such as Modbus RTU, Ethernet (also PoE), M-Bus
- All interfaces are programmable via the display

Screw thread:

Easy installation in existing piping through integrated measuring block (suitable for 1/4", 1/2", 3/4", 1", 1 1/4", 1 1/2" or 2" lines)

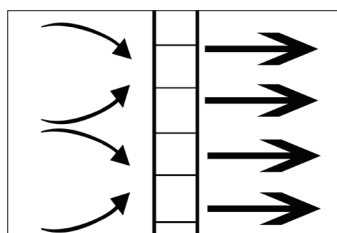

Integrated flow straightener - no inlet sections necessary



With keystroke:

- Reset counter
- Select units
- Parameterize interface

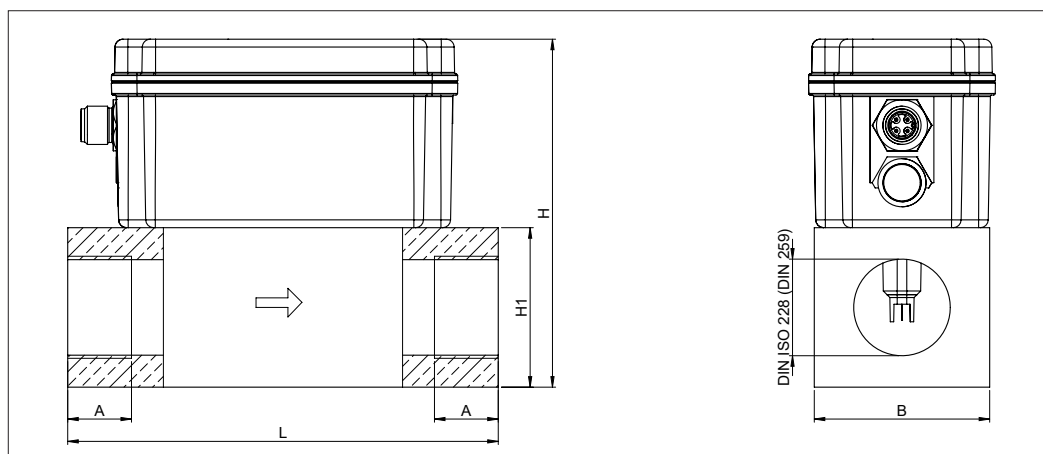

Measuring ranges flow VA 520 (Max version 185 m/s) for compressed air (ISO 1217: 1000 mbar, 20 °C). Measuring ranges for other types of gas see pages 94 to 97

Measuring section	Thread	Measuring range		L mm	B mm	H1 mm	H mm	A mm
		m ³ /h	cfm					
DN 8	G 1/4"	105 l/min	3,6	135	55	50	109,1	15
DN 15	G 1/2"	90 m ³ /h	50	135	55	50	109,1	20
DN 20	G 3/4"	170 m ³ /h	100	135	55	50	109,1	20
DN 25	G 1"	290 m ³ /h	170	135	55	50	109,1	25
DN 32	G 1 1/4"	530 m ³ /h	310	135	80	80	139,1	25
DN 40	G 1 1/2"	730 m ³ /h	430	135	80	80	139,1	25
DN 50	G 2"	1195 m ³ /h	700	135	80	80	139,1	30

Example order code VA 525:

0695 5250_A1_B1_C1_D1_E1_F1_G1_H1_I1_J1_K1_L1_M1_R1

Measuring block	
A1	1/4"
A2	1/2"
A3	3/4"
A4	1"
A5	1 1/4"
A6	1 1/2"
A7	2"

Threaded version	
B1	G female thread
B2	NPT female thread

Material	
C1	Aluminium

Calibration	
D1	No real gas adjustment - gas type setting by gas constant
D2	Real gas calibration in the gas type selected below

Typ of gas	
E1	Compressed air
E2	Nitrogen (N2)
E3	Argon (Ar)
E4	Carbon dioxide (CO2)
E5	Oxygen (O2)
E6	Nitrous oxide (N2O)
E90	Additional gas / please specify gas type (on request)
E91	Gas mixture (see page 72 - G91)

Measuring range (see table)	
F1	Low Speed version (50 m/s)
F2	Standard version (92,7 m/s)
F3	Max version (185 m/s)
F4	High Speed version (224 m/s)

Reference standard	
G1	20 °C, 1000 mbar
G2	0 °C, 1013,25 mbar
G3	15 °C, 981 mbar
G4	15 °C, 1013,25 mbar

Option display	
H1	with integrated display
H2	without display

Option pressure measurement	
I1	without pressure sensor
I2	with integrated pressure sensor 0 ... 16 bar

Option signal output/bus connection	
J1	4...20 mA analog output and pulse output
J2	Modbus-RTU (RS485)
J3	Ethernet-Interface (Modbus/TCP)
J4	Ethernet-Interface Power over Ethernet (Modbus/TCP)
J5	M-Bus

Rectifier	
K1	with integrated flow straightener, no additional inlet pipe necessary (with measuring block 1/2" to 2")
K2	without flow straightener (with measuring block 1/4")

Accuracy class	
L1	± 1,5% of m. v. ± 0,3% of f. s.
L2	± 6% of m. v. ± 0,5% of f. s.
L3	± 1% of m. v. ± 0,3% of f. s.

Maximum pressure	
M1	16 bar

Surface condition	
N1	Standard design
N2	Special cleaning oil and grease-free (e. g., for oxygen use, etc.)

Special measuring range	
R1	Special measuring range (please specify when ordering)

Order-No. VA 525

DESCRIPTION	ORDER-NR.
Compact inline flow sensor	0695 5250 + order code A...R_

TECHNICAL DATA VA 525	
Parameters:	m³/h, l/min (1000 mbar, 20 °C) in case of compressed air resp. Nm³/h, NI/min (1013 mbar, 0°C) in case of gases
Units adjustable via keys at display:	m³/h, m³/min, l/min, l/s, ft/min, cfm, m/s, kg/h, kg/min, g/s, lb/min, lb/h
Sensor:	Thermal mass flow sensor
Meas medium:	Air, gases
Gas types over CS Service Software or CS Datalogger adjustable:	Air, nitrogen, argon, CO2, oxygen
Measuring range:	See table above
Accuracy: (f. M. = from the measured value) (f. E. = from end value)	± 1,5 % of m. v. ± 0,3 % of f. s. By request: ± 1 % of m. v. ± 0,3 % of f. s. or ± 6 % of m. v. ± 0,5 % of f. s.
Pressure measurement:	0...16 bar, accuracy: 1%
Operating temp.:	-30...80 °C
Operating pressure:	Up to 16 bar
Digital output:	RS 485 interface (Modbus RTU), M-Bus (optional) Ethernet interface or PoE
Analog output:	4...20 mA for m³/h resp. l/min
Pulse output:	1 pulse per m³ or per liter galvanically isolated. Pulse value adjustable on the display. Alternatively, the pulse output can be used as an alarm relay.
Power supply:	18...36 VDC, 5 W
Burden:	< 500 Ω
Housing:	Polycarbonate (IP 65)
Meas. section:	Aluminium
Mounting thread meas. section:	G 1/4" to G 2" (BSP British standard piping) resp. 1/2" to 2" NPT-thread
Mounting position:	Any